

Features

- Arm features 5#" reach
- 1/2" NPT connection

Material

- Durable metal construction
- KOHLER finishes resist corrosion and tarnishing

Installation

- Wall-mount



Codes/Standards









ASME A112.18.1/CSA B125.1

KOHLER® One-Year Limited Warranty

See website for detailed warranty information.

Available Colors/Finishes

Color tiles intended for reference only.

Color	Code	Description
	CP	Polished Chrome
	SN	Vibrant™ Polished Nickel
	AF	Vibrant™ French Gold
	PB	Vibrant™ Polished Brass
	BN	Vibrant™ Brushed Nickel
	BV	Vibrant™ Brushed Bronze
	2BZ	Oil-Rubbed Bronze
	BL	Matte Black
	2MB	Vibrant™ Brushed Moderne Brass

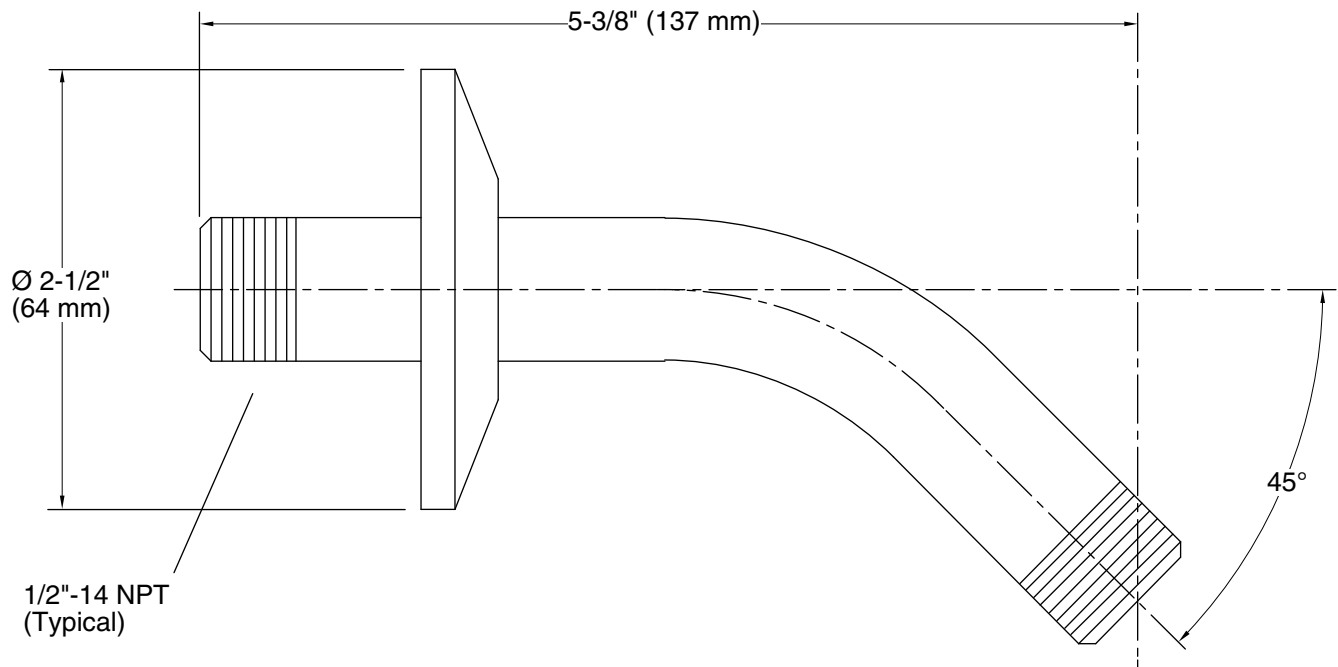

Technical Information

All product dimensions are nominal.